

AUSTRALIAN
DESIGNED, MADE
AND OWNED!

Harness the *power* of

The world's healthiest, coolest,
quietest most energy-efficient
evaporative air conditioners ever!

100% *healthier*
fresh filtered air
for total comfort

up to

80% *cheaper*

to run than reverse
cycle air conditioning²

Evaporative Air Conditioning



Breezair
By SEELEY INTERNATIONAL

Braemar
By SEELEY INTERNATIONAL

coolair
By SEELEY INTERNATIONAL

Harness the *po*



At Seeley, we harness the power of wind and water.

There's a natural attraction between air and water that is powerful...

Outside, these forces of nature live all around us. But, what if we could harness this power inside too?

Our evaporative air conditioning technology has been inspired by nature with beautiful design, incredible reliability and unsurpassed cooling performance using 100% fresh outside air - the only air you want to breathe!

Today, you can harness that power too.

Seeley International is renowned for world-class design and innovation, striking that delicate balance between form and function, just like nature.

We have a range of evaporative coolers that would seamlessly integrate with all roof lines without compromising on comfort, quality or environmental credentials, through to our traditional range that also deliver efficient, natural cooling for long lasting comfort.

Since day one, nearly 50 years ago, our company has been about challenging mindsets and stretching the imagination. Trust, reliability and innovation have been the cornerstones to success. It's no coincidence that Seeley International is the most awarded air conditioning manufacturer in Australia. We export our amazing products all around the globe.

At Seeley International, we don't settle for ordinary, and neither should you.



Frank Seeley

AM, DUniv Flin, FAICD
Founder and Executive Chairman



Power of nature

Harness the *healthiness* of 100% fresh air, the only air you want to breathe!

Award Winning Company

Seeley International consistently wins awards each year for new product design, innovation and environmental friendliness.

Recent awards include:

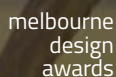

Front cover: 1. Based on published research articles, NATA certified laboratory test results and publicly sourced data.
2. Seeley International's calculation based on approximate running cost figures from publicly sourced data.

Australian designed, made and owned



Built by Australians, for an Australian climate.

Seeley International is proudly a 100% Australian owned company, designing and manufacturing world-leading air conditioning products for Australia and the world. As Australia's largest air conditioning manufacturer, we are a global leader in developing ingenious, energy-efficient cooling and heating products. Being made in Australia, you can rely on build quality, availability of parts and after sales service. We're extremely passionate, and dedicated to strengthening the Australian economy, supporting local employment and building on the skills of our workforce.

Why evaporative air conditioning?

The most healthy and energy efficient cooling experience for your home

Evaporative air conditioning delivers a natural, exceptionally healthy cooling experience in the place where people spend **most** of their time - **HOME**. Bringing an **endless supply** of **100%** fresh, cool, filtered outside air into the home, not taking moisture from the air, which **combats** dehydration. It is environmentally friendly as it does not use harmful refrigerants containing HCFC's or HFC's. It produces less CO₂ emissions than reverse cycle air conditioning due to its efficient, low energy use whilst cooling your whole home, and everyone in it. **PLUS evaporative air conditioning** drives everyone's **second-hand air out of the home**, along with the brain-numbing CO₂ which everyone exhales - making this the **HEALTHIEST** air conditioning.

It's kind to you, kind to the environment, kind to your cash-flow, making evaporative cooling the natural choice.



The healthiest choice

Improving the health, wellbeing and vitality of the whole family. Not taking moisture from the air, which combats dehydration.



Lowest running cost in Australia

Up to 80% cheaper to run². Save up to 80% on energy bills when compared to a reverse cycle air conditioner.



Fresh, cool clean air

Delivers **100% fresh**, filtered outside air, expelling the stale recycled air, and naturally cooling your **whole** home.



Quiet to run

Ask your dealer for a demonstration - see how **cool and whisper quiet** it is!



Built to last

Quality that lasts. Up to 7 years comprehensive warranty³.



Australian designed, made and owned!

Manufactured by family owned Seeley International, Australia's largest air conditioning manufacturer.



Environmentally friendly

Produces up to 80% less CO₂ emissions² - that's the equivalent of **planting 16 gum trees!**²

²Refer to page 7.



NATA Testing

NATA accredited laboratory test results substantiate superior product performance claims.



Technology that puts you in control

MagIQTouch[®] Controller technology for complete control of your comfort at home.



Low maintenance

Innovative design, minimising long term servicing.



Ultimate lifestyle

Perfect for alfresco living and busy families where children and pets keep coming in and out.



Minimal water usage

Evaporative air conditioning uses up to **94% less water** per year than a shower⁴.

²Seeley International's calculation based on approximate running cost figures from publicly sourced data. Comparison with 1.5 star not zoned ducted refrigerative system in a large size (220m²) 2-star pre 2005 house in a Melbourne climate, cooling all day on the weekend and in the mornings and evenings when internal temperatures are high, and an electricity tariff of 31.9c/kWh. Negligible water cost excluded. ³The 7 year comprehensive warranty is available exclusively (i.e. only) from Seeley International participating dealers. The warranty has terms and conditions, including the requirement for servicing of the product in accordance with the owner's manual. In the fourth year the service must be performed by Seeley International or its appointed nominee. ⁴Water use calculations for shower are based on shower water use for 4 people, 7 mins per person per day at 9L/min, over twelve months, calculated at 91,980 L. Water use calculations for Braemar unit LCB450 evaporative air conditioner over twelve months are 5,405 L.

Start enjoying **world-leading** evaporative air conditioning and become... **Healthier, Wealthier** and Environmentally **Wiser!**

Seeley International and your health

Evaporative air conditioning is better for you. Here's why:

- Evaporative air conditioners **continually cool and deliver 100% fresh, filtered, OUTSIDE AIR**, whereas reverse cycle air conditioners **re-circulate air** that you've **all been breathing and living in** for hours, and maybe days. This re-circulated air contributes to a build-up of CO2 in the home and CO2 is known to have an adverse effect on human health and well-being.
- Evaporative air conditioning naturally moisturises the air so **NO-ONE** suffers from the dryness caused by reverse cycle air conditioning.

Up to 80% cheaper to run

Using highly efficient inverter motors, our evaporative air conditioners deliver savings of up to 80% on your energy bills when compared to ducted reverse cycle systems. That's a **saving of up to \$250 per year!**²

Running costs per year²

Compared to a ducted reverse cycle system

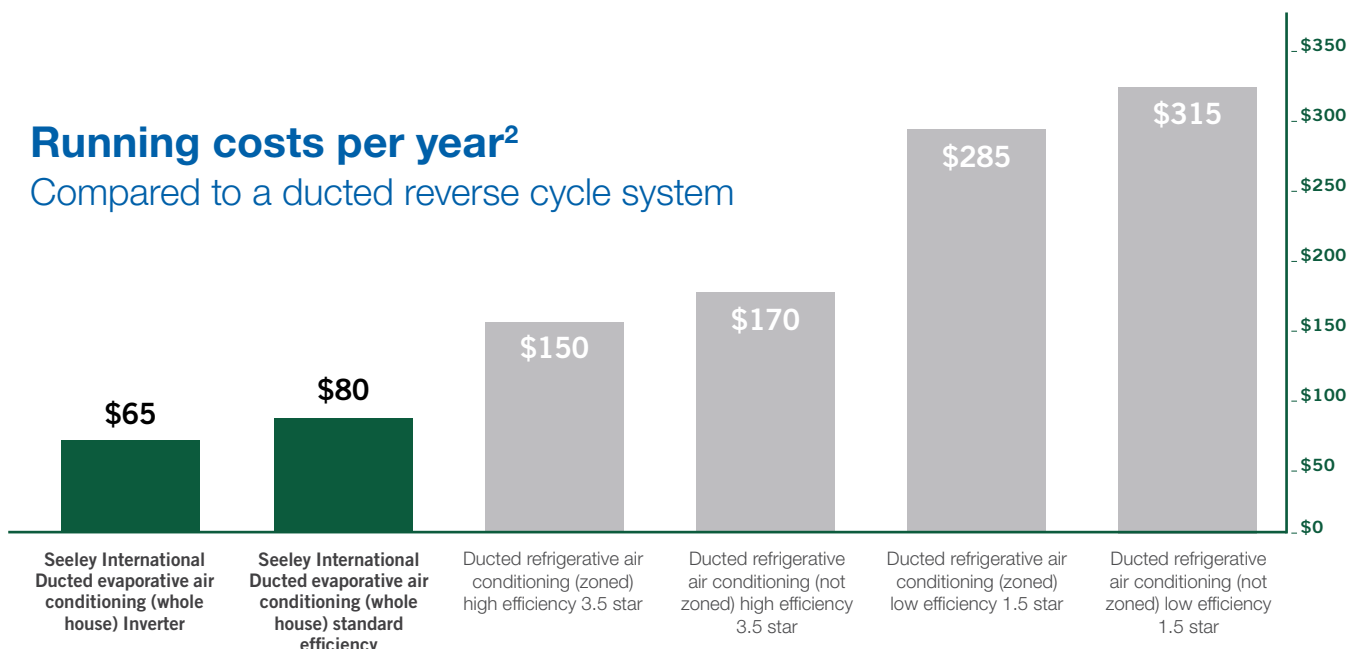

Incorporating **InvertaCool®** technology

- Quieter operation.
- Greater air flow control.
- Ultra-energy efficient, lower carbon emissions.
- Lower power bills.



² Seeley International's calculation based on approximate running cost figures from publicly sourced data. Comparison with 1.5 star not zoned ducted refrigerative system in a large size (220m²) 2-star pre 2005 house in a Melbourne climate, cooling all day on the weekend and in the mornings and evenings when internal temperatures are high, and an electricity tariff of 31.9c/kWh. Negligible water cost excluded.

Minimal water usage



Our water saving features:

- Superior water distribution system
- Water quality monitoring
- Auto-Clean™ - Automatic water drainage

The result: Minimum water usage for maximum, fresh cooling power.

Water consumption comparison across household appliances⁴

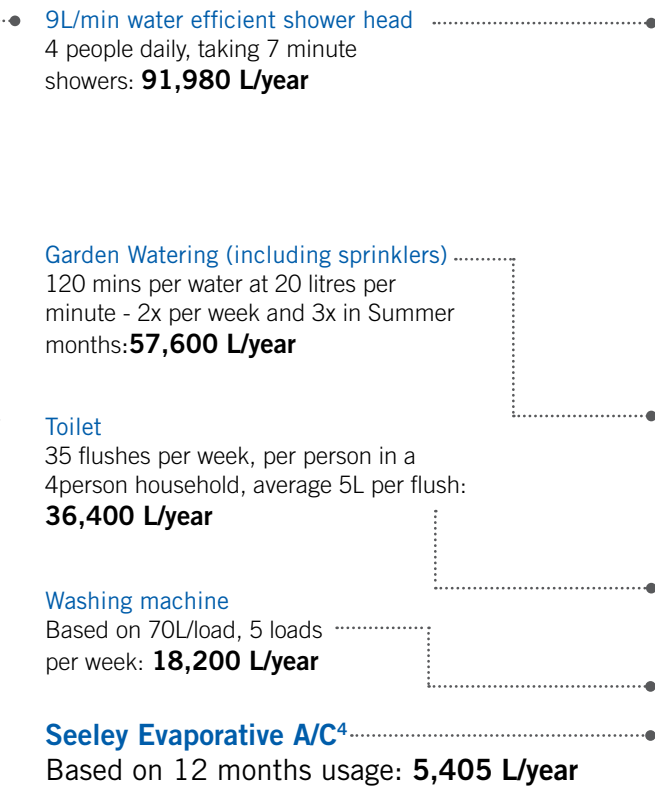

Reduce your carbon footprint



The power consumption of just one ducted refrigerated air conditioner can result in up to 1.4 tonnes of harmful CO₂ being pumped into the atmosphere each year. By purchasing a Seeley International evaporative air conditioner, which uses water, a **renewable resource**, to cool, you'll **reduce your impact on the environment** by producing up to **80% less CO₂ emissions⁵**, when compared to a ducted reverse cycle air conditioner.

CO₂ Emissions (kg/Yr)⁵

CO₂ savings equivalent to **planting 16 gum trees!**⁶

Compared to a ducted reverse cycle system

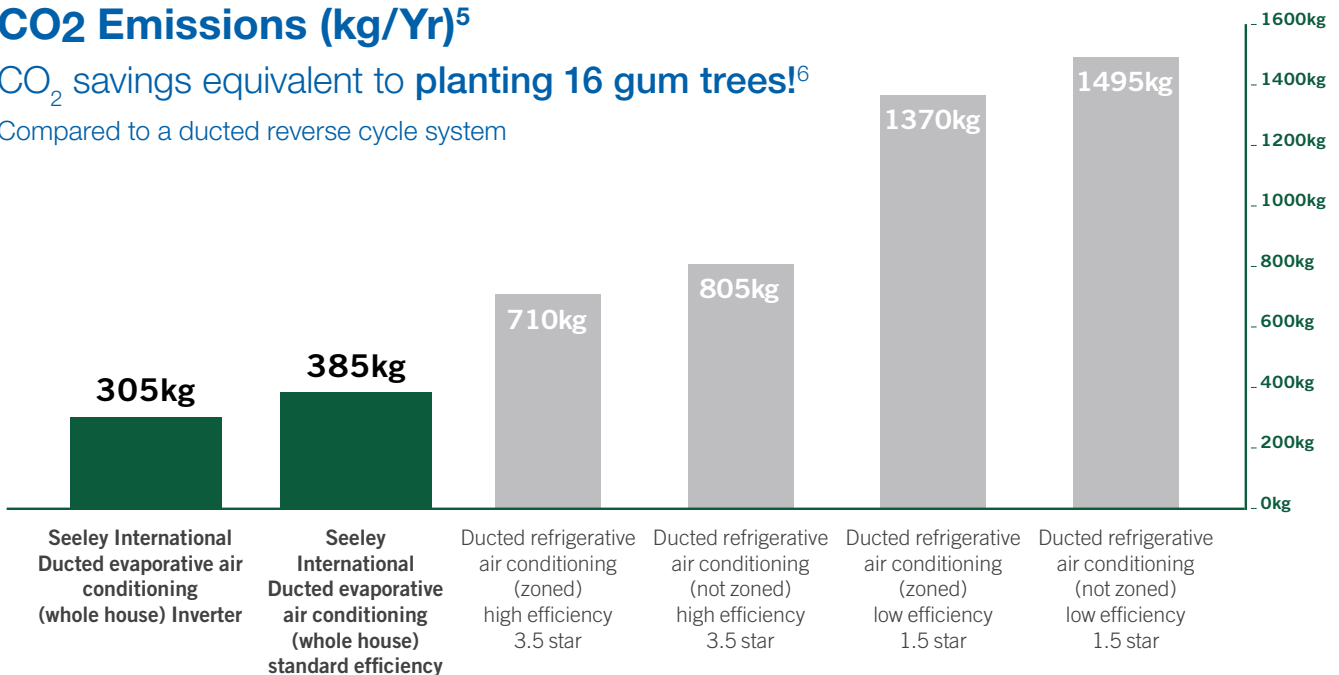

4. Water use calculations for Braemar unit LCB450 evaporative air conditioner over twelve months are 5,405 L. This comparison is based on usage in an average-size Australian home with 4 occupants.

5. Seeley International's calculation based on approximate greenhouse gas emissions figures from publicly sourced data. Comparison with 1.5 star not zoned ducted refrigerative system in a large size (220m²) 2-star pre 2005 house in a Melbourne climate, cooling all day on the weekend and in the mornings and evenings when internal temperatures are high.

6. This is an estimate based on the CO₂ calculation above and using the data from forestlearning.edu.au, 'Carbon and its storage in forest and wood products' article, published 2011. Calculation based on a spotted gum tree that sequesters 72kg CO₂/YR.

Harness the
power of
coolair
By **SEELEY INTERNATIONAL** ™



Affordable, effective cooling

Accessible evaporative air conditioning

The Coolair Brand became part of the Seeley International suite in 1997 and was quickly redeveloped to incorporate the all-plastic, corrosion-free construction which Seeley had pioneered.

The brand maintains its ethos of affordable effective cooling; presenting a good, value for money unit for those wanting to enjoy the benefits of evaporative cooling, without the cost of more advanced features.

Unit Snapshot:

- Variable speed motor
- Axial fan
- Automatic drain valve optional



The warranty has terms and conditions, including the requirement for regular servicing of the product in accordance with the owner's manual. Coolair 5 Year only warranty applies to products purchased from October 1st 2020.

Coolair range

CPQ Series

Coolair Evaporative air conditioners are very affordable, representing the **CHEAPEST-HIGHEST-VALUE-FOR-MONEY** coolers, which do not compromise on the renowned Seeley performance.

- Variable speed motor.
- State of the art axial fan.
- Contains a bleed valve for water management, suitable for harsh water quality regions.
- Proven track record for reliability and longevity.



Available colours⁸



Coolair... Australia's greatest value for money home cooling!

- ✓ Durability ensures long term trouble-free comfort!
- ✓ Efficiency, save up to 75% on energy costs².
- ✓ Australian designed, made and owned!
- ✓ Natural fresh, cool, clean, filtered air.
- ✓ NATA accredited test results substantiate superior product performance.
- ✓ Alfresco living with options for security vents so doors and windows can remain closed.

2. Seeley International's calculation based on approximate running cost figures from publicly sourced data. Comparison with 1.5 star not zoned ducted refrigerative system in a large size (220m²) 2-star pre 2005 house in a Melbourne climate, cooling all day on the weekend and in the mornings and evenings when internal temperatures are high, and an electricity tariff of 31.9c/kWh. Negligible water cost excluded. 8. Colours may vary, Terracotta made to order.

Harness the *heritage* of Coolair -
keeping Australians beautifully cool for
over 50 years!



Renowned cooling performance.

Coolair

Features and benefits

Exceptional water distribution increases cooling effect

Coolair's unique patented water distribution system means no clogging of the filter pads.

- Clever high efficiency pad wetting system.
- Total pad saturation for total cooling.
- **High performance cooling day and night.**

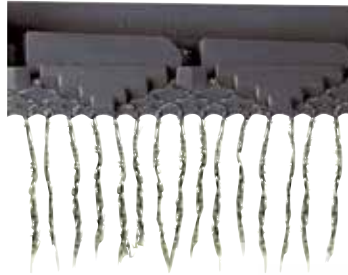

Tornado® pump that won't block

- Australian designed and manufactured.
- Built to outlast other less efficient conventional style pumps.
- Dual directional – it can't block!



Stealth® fan is whisper quiet

- Advanced aerodynamic design.
- Super quiet in operation.
- Produces **more** beautifully cool, quiet, refreshing breeze, and at a **fraction** of the running costs of alternatives!



Breakthrough Black Magic® Mini-cell⁷ Chillcel® pad technology

The only evaporative cooling medium of its kind. Fully manufactured in Australia to address the harsh Australian climate. **It's an absolute out-performer!**

- Exclusive small cell design provides cutting-edge high capacity cooling.
- Maintains our global leading Mini-Cell⁷ Chillcel® pad technology, which increases surface area of the **fully wetted pads** by 25%, dramatically increasing cooling capacity and efficiency - **BEYOND BELIEF!**
- **Black Magic® MINI-CELL⁷ CHILLCEL® pads** deliver superlative cooling and transformational aesthetics to your home, enabling the unit to blend seamlessly into its surroundings.



7. Patent pending



AutoWinterseal® reduces draughts and dust

- Automatically closes off the air conditioning ducts when not in use.
- Reduces winter chills entering your home.
- Ensures comfort all year round.

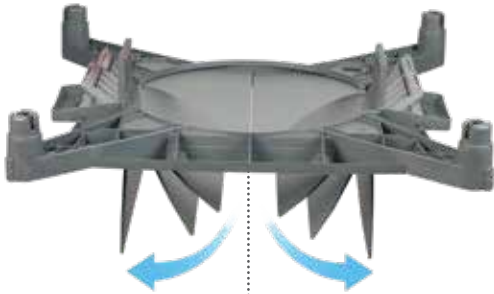

Highly durable and non-corrodible outer casing

- Visually discreet, low profile.
- Integrates unobtrusively with the roof line.
- High performance Permatuf® polymer construction.
- Highly durable, will not corrode or rust.
- Available in a range of contemporary colours.



Auto water draining keeps your system clean (optional)

- Reduces the amount of seasonal maintenance with this optional feature¹⁰.
- This clever device conserves water by retaining the system's water for up to 72 hours of non-operation.

Flexible control with MagIQcool®

The Coolair MagIQcool® controller is incredibly easy to use.

- Set your preferred temperature level on the clever wall mounted control and Coolair will do the rest - quickly, cleanly and reliably.
- Maintain your desired comfort level with four convenient modes to choose from - cool, vent, auto and timer.



Optional extra: MagIQtouch® Controller Touch screen technology





10.Regular maintenance (typically every two years for domestic use) is still required.

Breezair

Technical Specifications





 InvertaCool® technology used in these models





Model	Cooling capacity (kW)	Airflow (L/s) at 80Pa ¹¹	Nominal power motor (W)	Width (mm)	Depth (mm)	Height – Front (mm)	Height – Rear (mm)	Operating weight (kg)
Available at selected Seeley International Dealers								
 Extraordinaire XTR3000	12.4	2100	430	1160	1400	840	550	86
 Extraordinaire XTR4000	14.5	2480	600	1160	1400	840	550	86
 Extraordinaire XTR5000	17.4	2900	950	1160	1400	840	550	86

Model	Cooling capacity (kW)	Airflow (L/s) at 80Pa ¹¹	Nominal power motor (W)	Width (mm)	Depth (mm)	Height (mm)	Operating weight (kg)
Exclusive to CMSI Dealers							
 Supercool EXS160	11.4	1720	550	1160	1160	860	94
 Supercool EXS180	13.1	2060	750	1160	1160	860	94
 Supercool EXS 200	14.3	2320	1100	1160	1160	860	94
 Supercool EXS220	15.1	2540	1500	1160	1160	860	94
 Icon EXQ150	10.8	1720	550	1160	1160	860	90
 Icon EXQ170	11.6	2070	750	1160	1160	860	90
 Icon EXQ190	13.8	2290	1100	1160	1160	860	90
 Icon EXQ210	14.5	2540	1500	1160	1160	860	91

Braemar

Technical Specifications

Model	Cooling capacity (kW)	Airflow (L/s) at 80Pa ¹¹	Nominal power motor (W)	Length (mm)	Width (mm)	Height – Front (mm)	Height – Rear (mm)	Operating weight (kg)
 Evolution LPQI250	8.4	1510	340	1150	1150	730	380	86
 Evolution LPQI350	10.4	2010	430	1150	1150	730	380	86
 Evolution LPQI450	11.8	2390	600	1150	1150	730	380	86
 Evolution LPQI550	13.2	2850	950	1150	1150	730	380	86

Model	Cooling capacity (kW)	Airflow (L/s) at 80Pa ¹¹	Nominal power motor (W)	Length (mm)	Width (mm)	Height (mm)	Operating weight (kg)
 SuperStealth LCQI250	8.1	1500	340	1150	1150	685	88
 SuperStealth LCQI350	9.9	1990	430	1150	1150	685	88
 SuperStealth LCQI450	13.5	2620	600	1150	1150	835	91
 SuperStealth LCQI550	14.3	3070	950	1150	1150	835	91
Paradigm LCQ350	10.2	1980	430	1150	1150	685	80
Paradigm LCQ450	13.2	2560	600	1150	1150	835	89
Paradigm LCQ550	14.1	2810	950	1150	1150	835	91



Refer to page 6 for details of benefits.

¹¹ Airflow performances at 80Pa - the equivalent duct static pressure of typical ducted residential multiple outlet installations. The above data was drawn from Meridian Test Laboratory's test analysis. The testing was performed by a NATA accredited laboratory to the requirements of the Australian standard AS2913-2000 "Evaporative Air Conditioning Equipment." Achievable with ambient 38 °C DB, 21 °C WB, room temperature 27.4 °C.

Coolair

Technical Specifications

Model	Cooling capacity (kW)	Airflow (L/s) at 80Pa ¹	Nominal power motor (W)	Width (mm)	Depth (mm)	Height (mm)	Operating weight (kg)
CPQ450	8.0	1570	340	1150	1150	685	78
CPQ700	9.5	2000	430	1150	1150	685	79
CPQ850	11.8	2560	600	1150	1150	835	87
CPQ1100	13.3	2710	750	1150	1150	835	89

How do I choose?

The airflow, and size of the area you wish to cool, will be the largest determinants of which model is best suited to your needs. Whilst it may seem that bigger can only be better, a correctly sized air conditioner for your home will run far more efficiently, which equates to maximised electricity cost savings.

- **Is your home well insulated?** This is a key consideration, as it impacts your home's ability to maintain its temperature. A well insulated home may need a lower capacity unit, in comparison to a poorly insulated home.
- **What climate will your home operate in?** The hotter the climate, the greater the demand on your air conditioning.
- **What additional benefits are important to you?** Seeley International evaporative air conditioners offer additional technology benefits like winter seals, SuperStealth® fans, inverter motors, water savers, and architecturally designed units for greater aesthetic appeal.



The Breezair Supercool® range is available exclusively through Climate Masters of Seeley International Dealers.



Harness the *simplicity* of **MAGI@TOUCH**® controller

Touch screen technology

Smart, sophisticated and incredibly intuitive, your MagIQtouch® controller makes operating your evaporative air conditioner a breeze. Control the temperature, fan speed and many more features on a user friendly touch screen. The discreet and modern design will blend seamlessly into the décor of your home.

Main Features



Program mode

Programmable 7 day, 4 time period program, customisable to suit your lifestyle (including a temporary over-ride function).



Energy saving quiet night mode

A comfortable nights sleep that won't cost the earth. The energy saving quiet night mode automatically reduces fan speed during the night for even greater economy at lower noise levels.



Manual mode

Manually control temperature and/or fan speed settings, at will.



Cooling & Heating

Control both your cooling and heating from one MagIQtouch® controller.



Auto-clean™ Function

World's first fully automated pad cleansing capability enables you to set and forget, ensuring your cooling pads remain clean, fresh and functional all summer long, season after season¹².



Useful settings

Access additional features such as child lock, and servicing information.

Optional Extra: MagIQtouch® Air Sensor

The MagIQtouch® Air Sensor monitors temperature and humidity levels. It allows you to mount your MagIQtouch® controller in the most convenient place in your home, as the MagIQtouch® Air Sensor will then take over temperature control from the MagIQtouch® controller. This can then be located in the best place in the house to ensure ultimate cooling comfort for everyone.



Wi-Fi Smart app¹³



Control your cooling comfort needs directly from your mobile device! For example, turn on your cooler wherever you are, ensuring you come home to a cool home on those hot summer days.

The smart app is free and available for download on your smartphone.

Smart home integration¹³



Control temperature and fan speeds with your voice through Amazon¹⁴ Alexa or Google Assistant¹⁵ technologies.

Voice commands are easy and simple to use, like "Alexa, turn on my Cooler" or "Hey Google, set the Cooler to 21 degrees".

¹².Only for cooler models fitted with the water management system. Ask your dealer for further information.

¹³.Requires MagIQtouch® wall control, MagIQtouch® Wi-Fi smart kit and MagIQtouch® account to operate. Additional costs may apply.

¹⁴.Requires Wi-Fi, Google Account and a compatible device. Google and Google Home are trademarks of Google LLC. Additional costs may apply.

¹⁵.Requires Wi-Fi, Amazon Account and a compatible device. Additional costs may apply.

Harness the *power* of wifi and wireless



Controller upgrade options



Wireless:

- Battery operated Wireless Controller using Radio Frequency technology.
- Ideal for renovations, or where access for cabling is limited.
- Easier to install, the RF option also provides up to 2 master controllers.
- Can control the entire system from 2 locations, rather than 1; an ideal solution for larger, or two storey homes.



Wifi Enabled¹⁶:

- **Take complete control of your comfort at home, at all times.**
- Upgrade to a WI-FI module to work with your wired-in MagiQtouch® Controller,¹⁷ enabling you to control your heating directly from your personal device through our smart app.
- The Smart app is available on Android and IOS devices.
- Integrate into voice activated smart home controls like Google Home and Amazon Alexa.

16.Requires MagiQtouch® WI-FI kit, compatible MagiQtouch® controller and MagiQtouch® account to operate. Additional costs may apply.

17.MagiQtouch® WI-FI Module is not compatible with MagiQtouch Wireless Controller. Existing installations including a MagiQtouch® controller may need to be upgraded if purchasing the WI-FI module. Additional costs may apply.



Google Home



amazon echo



Available for download now on iOS and Android



Additional Information

Combined heating and cooling solution

A Seeley International Ducted Gas Heater will complement your Evaporative cooling system:

- Warm and cosy in winter; fresh and cool in summer!
- MagIQtouch® controller will seamlessly control **both** heater and cooler systems.
- Braemar has the highest efficiency star ratings in Australia for ducted gas heating¹⁸.



Keep your home secure

Did you know you can cool your home without leaving your doors and windows open?

Cost effective and easy to install, the **Security Relief Vent™** allows you to run your evaporative air conditioner while you are out, with all your windows and doors safely closed and locked.

Your home will **stay** cool, because the **cool** exhaust air is released into the hot roof space, cooling everything while you're out.

When you return home, if you wish, simply open up your windows and doors as normal - either way, you will **maintain** the delivery of fresh, cool air **throughout** your home.



Bushfire protection

Firewall Ember Screen (optional extra)

- Helps guard against ember attack in bushfires.
- Made from non-combustible mesh.
- Maximum aperture of 2mm.
- Can be fitted to existing cooler pad frames.
- Minimal reduction in air flow of around 5%.
- To meet BAL ratings, the cooler **also** requires a Firewall Auto Seal installed.
- Fitting both Ember Screen and Auto Seal to comply with BAL ratings will reduce airflow by up to 15%.

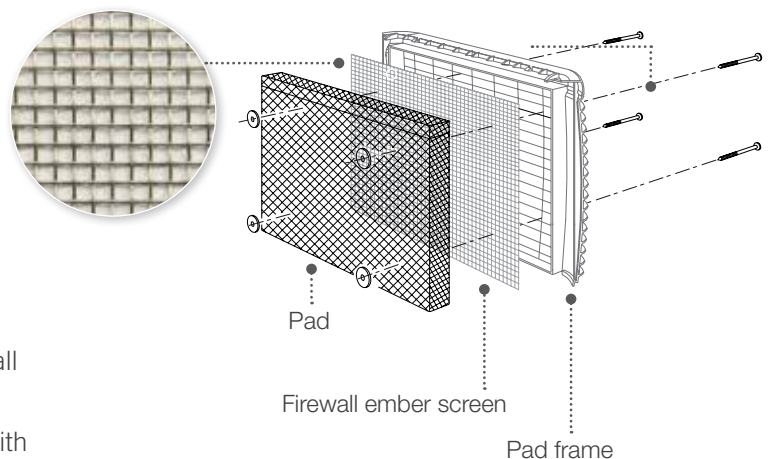

Warranty Terms

7 Year Warranty - Breezair & Braemar

7 year Comprehensive Warranty¹⁹, 10 year cover on all structural components, plus a hefty 25 year cover against corrosion, on its Permatuf[®] cabinet.



5 Year Warranty - Coolair²⁰

5 year Warranty, 10 year cover on all structural components, plus a hefty 25 year cover against corrosion, on its Permatuf[®] cabinets.



Register your warranty and go into the draw to win a prize worth \$500²¹.

Prize includes 2 free services (up to the value of \$400) and a \$100 eftpos gift card

All you need is your home owners' manual.

Visit [seeleyinternational.com/warranty](https://www.seeleyinternational.com/warranty) and follow the prompts.

Have your serial number ready.

18. 3 to 6 star, and 7 star equivalent products.

20. Coolair 5 Year only warranty applies to products purchased from October 1st 2020.

21. Terms and conditions apply.

See: <https://www.seeleyinternational.com/residential/support/warranty-prize-draw-winners/> for more information, including the dates of the promotion.





Harness the *power* of nature



BREEZAIR

Ducted Evaporative Air Conditioning

BRAEMAR

Ducted Evaporative Air Conditioning | Ducted Gas Heating
Reverse Cycle Air Conditioning | Gas Wall Furnaces and Space Heaters

THE CLIMATE WIZARD

Micro-Core® Technology

SUPERCool

Ducted Evaporative Air Conditioning

COOLAIR

Ducted Evaporative Air Conditioning

COOLERADO

Indirect Evaporative Air Conditioning

AIRA

Direct and Indirect Evaporative Air Conditioning | Ducted Gas Heating
Commercial Gas Space Heating | Energy Recovery Systems

INTEGRATED COMFORT INCORPORATED (ICI)

Dual Cool® Patented Dual Evaporative pre-cooling products

seeleyinternational.com/residential

1300 360 815

2022



With the generous support of our Australasian dealers we are proud to be the National Variety Bash partner supporting kids in need across Australia.

Seeley International Pty Ltd
ABN 23 054 687 035

112 O'Sullivan Beach Road, Lonsdale, SA 5160

Phone: (08) 8328 3850 Fax: (08) 8328 3950

Email: enquiries@seeleyinternational.com

seeleyinternational.com

Information in this brochure was correct at the time of preparation. E & OE



Cat No BML01 REV B DEALER (0921)