

AUSTRALIAN  
DESIGNED, MADE  
AND OWNED!

# Harness the *power* of

The world's healthiest, coolest,  
quietest most energy-efficient  
evaporative air conditioners ever!

**100%** *healthier*  
fresh filtered air  
for total comfort

up to

**80%** *cheaper*

to run than reverse  
cycle air conditioning<sup>2</sup>

Evaporative Air Conditioning



**Breezee**  
By SEELEY INTERNATIONAL

**Braemar**  
By SEELEY INTERNATIONAL

**coolair**  
By SEELEY INTERNATIONAL

# Harness the *po*



## **At Seeley, we harness the power of wind and water.**

There's a natural attraction between air and water that is powerful...

Outside, these forces of nature live all around us. But, what if we could harness this power inside too?

Our evaporative air conditioning technology has been inspired by nature with beautiful design, incredible reliability and unsurpassed cooling performance using 100% fresh outside air - the only air you want to breathe!

Today, you can harness that power too.

Seeley International is renowned for world-class design and innovation, striking that delicate balance between form and function, just like nature.

We have a range of evaporative coolers that would seamlessly integrate with all roof lines without compromising on comfort, quality or environmental credentials, through to our traditional range that also deliver efficient, natural cooling for long lasting comfort.

Since day one, nearly 50 years ago, our company has been about challenging mindsets and stretching the imagination. Trust, reliability and innovation have been the cornerstones to success. It's no coincidence that Seeley International is the most awarded air conditioning manufacturer in Australia. We export our amazing products all around the globe.

At Seeley International, we don't settle for ordinary, and neither should you.



*Frank Seeley*

AM, DUniv Flin, FAICD  
Founder and Executive Chairman



# Power of nature

Harness the *healthiness* of 100% fresh air, the only air you want to breathe!

## Award Winning Company

Seeley International consistently wins awards each year for new product design, innovation and environmental friendliness.

Recent awards include:



Front cover: 1. Based on published research articles, NATA certified laboratory test results and publicly sourced data.  
2. Seeley International's calculation based on approximate running cost figures from publicly sourced data.

# Australian designed, made and owned



## Built by Australians, for an Australian climate.

Seeley International is proudly a 100% Australian owned company, designing and manufacturing world-leading air conditioning products for Australia and the world. As Australia's largest air conditioning manufacturer, we are a global leader in developing ingenious, energy-efficient cooling and heating products. Being made in Australia, you can rely on build quality, availability of parts and after sales service. We're extremely passionate, and dedicated to strengthening the Australian economy, supporting local employment and building on the skills of our workforce.



# Why evaporative air conditioning?

The most healthy and energy efficient cooling experience for your home

Evaporative air conditioning delivers a natural, exceptionally healthy cooling experience in the place where people spend **most** of their time - **HOME**. Bringing an **endless supply** of **100%** fresh, cool, filtered outside air into the home, not taking moisture from the air, which **combats** dehydration. It is environmentally friendly as it does not use harmful refrigerants containing HCFC's or HFC's. It produces less CO<sub>2</sub> emissions than reverse cycle air conditioning due to its efficient, low energy use whilst cooling your whole home, and everyone in it. **PLUS evaporative air conditioning** drives everyone's **second-hand air out of the home**, along with the brain-numbing CO<sub>2</sub> which everyone exhales - making this the **HEALTHIEST** air conditioning.

**It's kind to you, kind to the environment, kind to your cash-flow, making evaporative cooling the natural choice.**



## The healthiest choice

Improving the health, wellbeing and vitality of the whole family. Not taking moisture from the air, which combats dehydration.



## Lowest running cost in Australia

Up to 80% cheaper to run<sup>2</sup>. Save up to 80% on energy bills when compared to a reverse cycle air conditioner.



## Fresh, cool clean air

Delivers **100% fresh**, filtered outside air, expelling the stale recycled air, and naturally cooling your **whole** home.



## Quiet to run

Ask your dealer for a demonstration - see how **cool and whisper quiet** it is!



## Built to last

Quality that lasts. Up to 7 years comprehensive warranty<sup>3</sup>.



## Australian designed, made and owned!

Manufactured by family owned Seeley International, Australia's largest air conditioning manufacturer.



## Environmentally friendly

Produces up to 80% less CO<sub>2</sub> emissions<sup>2</sup> - that's the equivalent of **planting 16 gum trees!**<sup>2</sup>

<sup>2</sup>Refer to page 7.



## NATA Testing

NATA accredited laboratory test results substantiate superior product performance claims.



## Technology that puts you in control

MagIQTouch<sup>®</sup> Controller technology for complete control of your comfort at home.



## Low maintenance

Innovative design, minimising long term servicing.



## Ultimate lifestyle

Perfect for alfresco living and busy families where children and pets keep coming in and out.



## Minimal water usage

Evaporative air conditioning uses up to **94% less water** per year than a shower<sup>4</sup>.

<sup>2</sup>Seeley International's calculation based on approximate running cost figures from publicly sourced data. Comparison with 1.5 star not zoned ducted refrigerative system in a large size (220m<sup>2</sup>) 2-star pre 2005 house in a Melbourne climate, cooling all day on the weekend and in the mornings and evenings when internal temperatures are high, and an electricity tariff of 31.9c/kWh. Negligible water cost excluded. <sup>3</sup>The 7 year comprehensive warranty is available exclusively (i.e. only) from Seeley International participating dealers. The warranty has terms and conditions, including the requirement for servicing of the product in accordance with the owner's manual. In the fourth year the service must be performed by Seeley International or its appointed nominee. <sup>4</sup>Water use calculations for shower are based on shower water use for 4 people, 7 mins per person per day at 9L/min, over twelve months, calculated at 91,980 L. Water use calculations for Braemar unit LCB450 evaporative air conditioner over twelve months are 5,405 L.

# Start enjoying **world-leading** evaporative air conditioning and become... **Healthier, Wealthier** and Environmentally **Wiser!**

## Seeley International and your health

Evaporative air conditioning is better for you. Here's why:

- Evaporative air conditioners **continually cool and deliver 100% fresh, filtered, OUTSIDE AIR**, whereas reverse cycle air conditioners **re-circulate air** that you've **all been breathing and living in** for hours, and maybe days. This re-circulated air contributes to a build-up of CO2 in the home and CO2 is known to have an adverse effect on human health and well-being.
- Evaporative air conditioning naturally moisturises the air so **NO-ONE** suffers from the dryness caused by reverse cycle air conditioning.

## Up to 80% cheaper to run

Using highly efficient inverter motors, our evaporative air conditioners deliver savings of up to 80% on your energy bills when compared to ducted reverse cycle systems. That's a **saving of up to \$250 per year!**<sup>2</sup>

### Running costs per year<sup>2</sup>

Compared to a ducted reverse cycle system

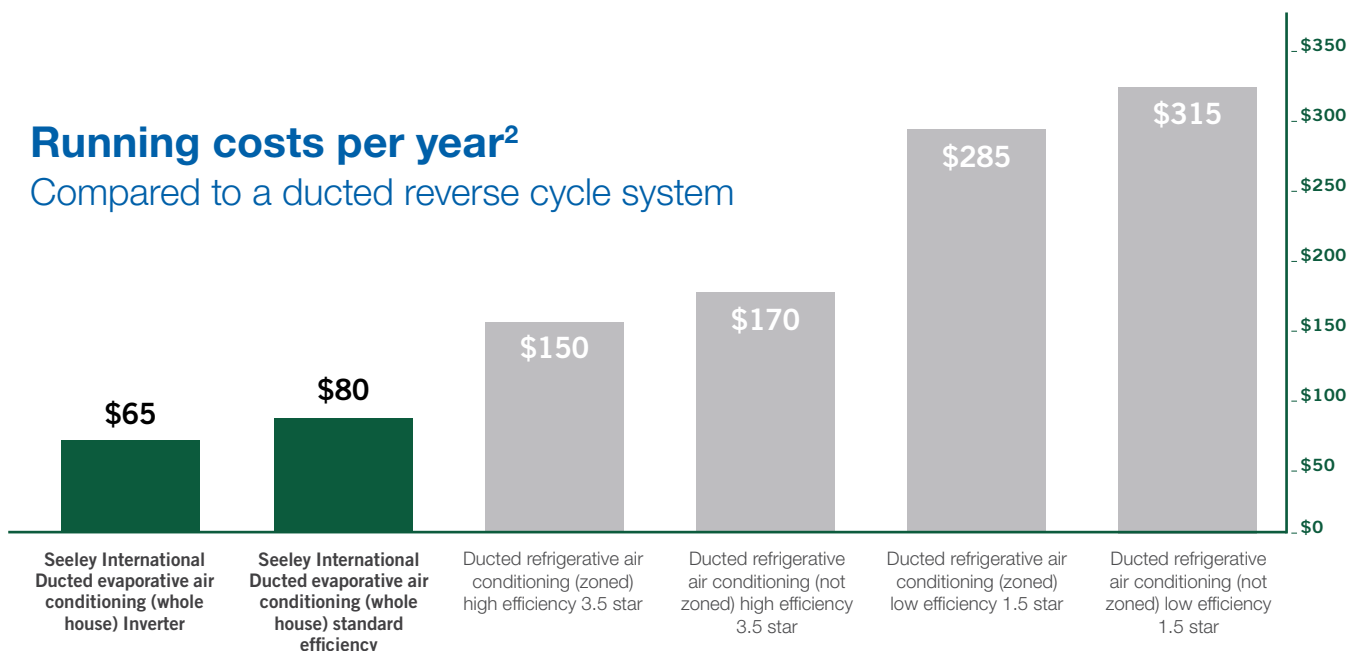

### Incorporating **InvertaCool®** technology

- Quieter operation.
- Greater air flow control.
- Ultra-energy efficient, lower carbon emissions.
- Lower power bills.



<sup>2</sup> Seeley International's calculation based on approximate running cost figures from publicly sourced data. Comparison with 1.5 star not zoned ducted refrigerative system in a large size (220m<sup>2</sup>) 2-star pre 2005 house in a Melbourne climate, cooling all day on the weekend and in the mornings and evenings when internal temperatures are high, and an electricity tariff of 31.9c/kWh. Negligible water cost excluded.

# Minimal water usage



Our water saving features:

- Superior water distribution system
- Water quality monitoring
- Auto-Clean™ - Automatic water drainage

The result: Minimum water usage for maximum, fresh cooling power.

## Water consumption comparison across household appliances<sup>4</sup>

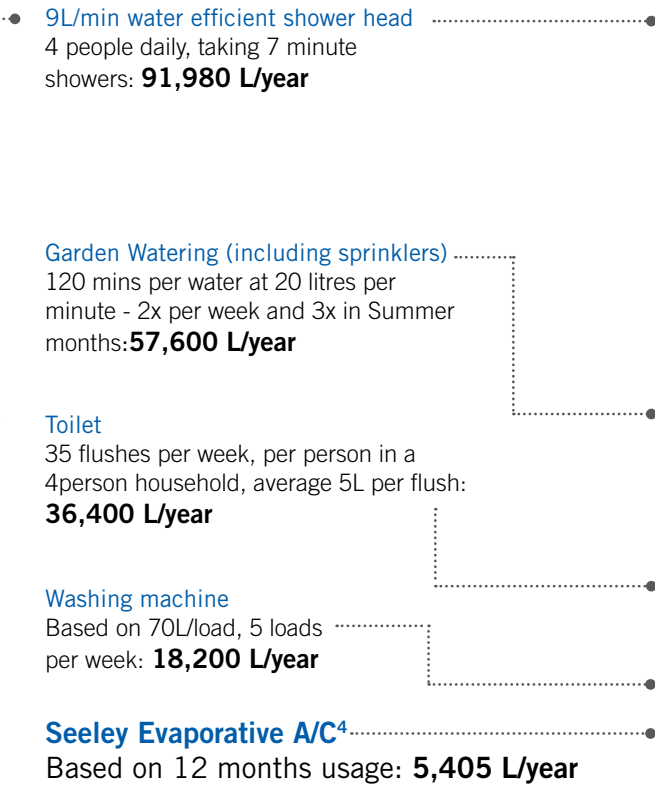

# Reduce your carbon footprint



The power consumption of just one ducted refrigerated air conditioner can result in up to 1.4 tonnes of harmful CO<sub>2</sub> being pumped into the atmosphere each year. By purchasing a Seeley International evaporative air conditioner, which uses water, a **renewable resource**, to cool, you'll **reduce your impact on the environment** by producing up to **80% less CO<sub>2</sub> emissions<sup>5</sup>**, when compared to a ducted reverse cycle air conditioner.

## CO<sub>2</sub> Emissions (kg/Yr)<sup>5</sup>

CO<sub>2</sub> savings equivalent to **planting 16 gum trees!**<sup>6</sup>

Compared to a ducted reverse cycle system

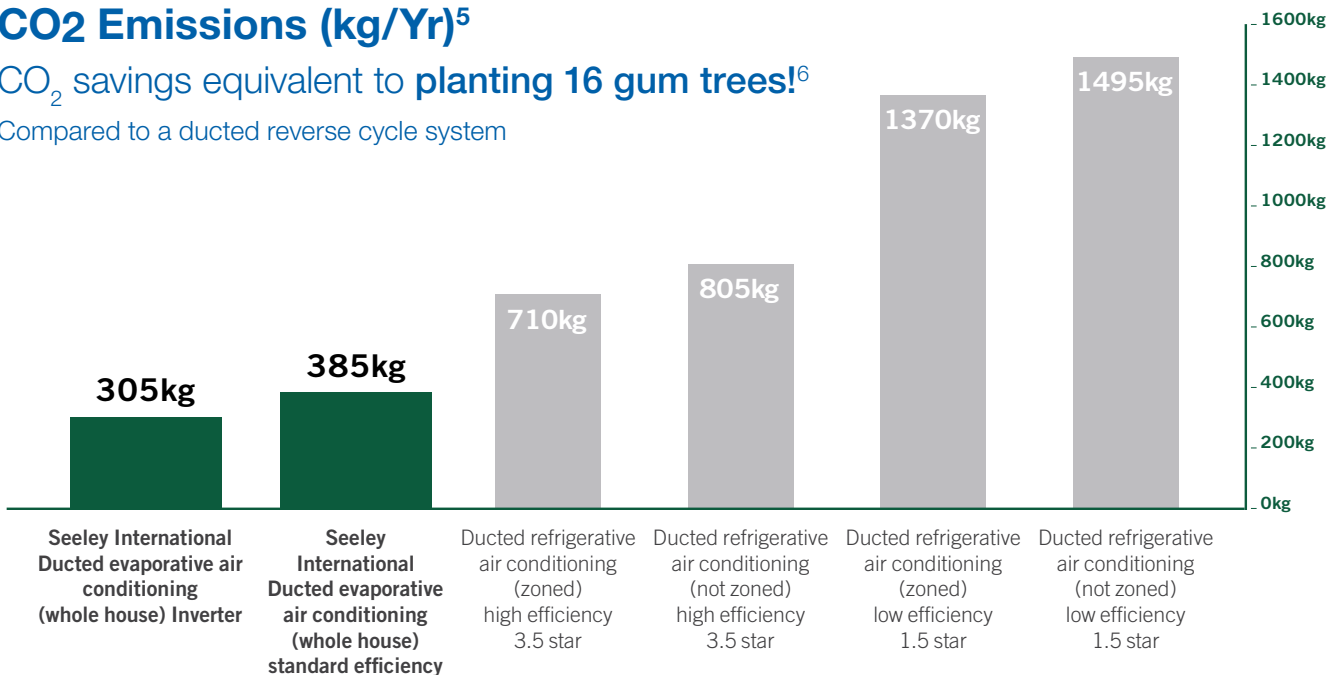

4. Water use calculations for Braemar unit LCB450 evaporative air conditioner over twelve months are 5,405 L. This comparison is based on usage in an average-size Australian home with 4 occupants.

5. Seeley International's calculation based on approximate greenhouse gas emissions figures from publicly sourced data. Comparison with 1.5 star not zoned ducted refrigerative system in a large size (220m<sup>2</sup>) 2-star pre 2005 house in a Melbourne climate, cooling all day on the weekend and in the mornings and evenings when internal temperatures are high.

6. This is an estimate based on the CO<sub>2</sub> calculation above and using the data from forestlearning.edu.au, 'Carbon and its storage in forest and wood products' article, published 2011. Calculation based on a spotted gum tree that sequesters 72kg CO<sub>2</sub>/YR.

Harness the  
*power* of  
**Braemar**

By SEELEY INTERNATIONAL ™



**AUSTRALIAN  
DESIGNED, MADE  
AND OWNED!**



# Inspirational comfort, combined with ultra-energy efficiency!

## A reputation built on quality and endurance

Founded in 1938 and being the oldest of Seeley International's brands, Braemar remains one of Australia's most recognised and trusted brand names today.

Backed by an 80 year history of innovation and success, the Braemar range is the recipient of many industry awards, including:

- The prestigious Good Design Awards in 2018 for the Braemar Evolution range.
- The Product Design Award in 2016 for the SuperStealth®
- Winner of the prestigious 2016 Australian Business Award.

These Awards reflect Braemar's commitment to sustainability; recognising its reduced energy usage, ultra-low noise, and reduced impact on the environment.

### Braemar benefits:

- Superstealth® Axial Fan
- InvertaCool® motor
- Trusted brand for over 80 years



This warranty has terms and conditions, including the requirement for regular servicing of the product in accordance with the owner's manual.

# Braemar range

## Evolution

With its low profile, superb design, the Braemar Evolution unobtrusively sits below the roof ridgeline to blend seamlessly with your home.

- InvertaCool® motor, using far less energy than a standard motor.
- Superstealth® axial fan.
- Ultra quiet.
- 24% more active chillcell cooling pad area than the Paradigm™.
- The **Lowest Profile Range** of high-performers!

Available colours<sup>8</sup>



## SuperStealth® Invertair® Series

The world's first high performance inverter axial evaporative air conditioner with the highest cooling capacity and energy efficiency in the Braemar range.

- Ultra-quiet cooling.
- Outstanding high-performance cooling.
- Patented ultra quiet SuperStealth® fan (quieter than the standard stealth fan).

Available colours<sup>8</sup>



## Paradigm Series™

Proven performer

- Braemar quality and reliability.
- High efficiency and cooling performance.
- Premium water management system.

Available colours<sup>8</sup>



<sup>8</sup>.Colours may vary, Heritage Green made to order.



Harness the *brilliance* of  
Braemar Evolution!



The coolest, compact, low profile air conditioner in the world.

## Features and benefits

### Exceptional water distribution

The water distribution system includes a combination of pressurised and free-flowing water systems, providing:

- Even water flow over the sides of the top pannel, ensures maximum pad area and maximum cooling at all times.
- Australian designed, world patented, free flow, water distributor ensures constant, even pad saturation increasing the cooling capacity and outperforming competitor products.

### Breakthrough Black Magic® MINI-CELL<sup>7</sup> CHILLCEL<sup>®</sup> pad technology

- The only evaporative cooling medium of its kind. Fully manufactured in Australia to address the harsh Australian climate. It's an **absolute out-performer!**
- Exclusive small cell design provides cutting-edge, high capacity cooling in a class of its own.
- Maintains our global leading Mini-Cell<sup>7</sup> Chillcel<sup>®</sup> pad technology, which increases surface area of the **fully wetted pads** by 25%, dramatically increasing cooling capacity and efficiency - **BEYOND BELIEF!**
- **Black Magic<sup>®</sup> MINI-CELL<sup>7</sup> CHILLCEL<sup>®</sup> pads** deliver superlative cooling and transformational aesthetics to your home, enabling the unit to blend seamlessly into its surroundings.

### Power control module helps save water and power

- Microprocessor constantly analyses water quality, water consumption and power output.

### Tornado<sup>®</sup> pump that won't block

- Australian designed and manufactured.
- Exceptional reliability in extreme conditions.
- Dual directional – it can't block!



### Auto Cleanse™ - Auto water draining keeps your system clean

- Empties the reservoir automatically when system is not in use, leaving it clean and dry.
- Ensures the system always operates at maximum efficiency, while using the minimum amount of water.
- Helps to reduce seasonal maintenance<sup>9</sup> as required by some other brands.

7. Patent pending. 9. Seasonal maintenance does not replace regular maintenance of the unit as required for peak performance.





**UV stabilised and corrosion free**

- The cabinet and water reservoir components are injection moulded structural foam polypropylene (Permatuf®) and are UV stabilised and non-corrodible.



**SuperStealth® Technology**  
(Evolution & SuperStealth® models)

- Advanced aerodynamic design.
- SuperStealth® InvertaCool® motor and SuperStealth® fan for high energy efficiency and whisper quiet operation.



**WaterManager™ saves water**

- Uses the minimum amount of water to achieve high efficiency cooling.
- Water quality monitoring to maximise water savings.
- Keeps your system clean on the inside.

**AutoWinterseal® reduces draughts and dust**

- Automatically closes off the air conditioning ducts when not in use.
- Reduces winter chills entering your home.
- Ensures comfort all year round.

**Bushfire Protection**

**Firewall Ember Screen (optional extra)**



- Helps guard against ember attack in bushfires.

Turn to **page 30** for more information.

# Breezair

## Technical Specifications





 InvertaCool® technology used in these models





Model	Cooling capacity (kW)	Airflow (L/s) at 80Pa <sup>11</sup>	Nominal power motor (W)	Width (mm)	Depth (mm)	Height – Front (mm)	Height – Rear (mm)	Operating weight (kg)
Available at selected Seeley International Dealers								
 Extraordinaire XTR3000	12.4	2100	430	1160	1400	840	550	86
 Extraordinaire XTR4000	14.5	2480	600	1160	1400	840	550	86
 Extraordinaire XTR5000	17.4	2900	950	1160	1400	840	550	86

Model	Cooling capacity (kW)	Airflow (L/s) at 80Pa <sup>11</sup>	Nominal power motor (W)	Width (mm)	Depth (mm)	Height (mm)	Operating weight (kg)
Exclusive to CMSI Dealers							
 Supercool EXS160	11.4	1720	550	1160	1160	860	94
 Supercool EXS180	13.1	2060	750	1160	1160	860	94
 Supercool EXS 200	14.3	2320	1100	1160	1160	860	94
 Supercool EXS220	15.1	2540	1500	1160	1160	860	94
 Icon EXQ150	10.8	1720	550	1160	1160	860	90
 Icon EXQ170	11.6	2070	750	1160	1160	860	90
 Icon EXQ190	13.8	2290	1100	1160	1160	860	90
 Icon EXQ210	14.5	2540	1500	1160	1160	860	91

# Braemar

## Technical Specifications

Model	Cooling capacity (kW)	Airflow (L/s) at 80Pa <sup>11</sup>	Nominal power motor (W)	Length (mm)	Width (mm)	Height – Front (mm)	Height – Rear (mm)	Operating weight (kg)
 Evolution LPQI250	8.4	1510	340	1150	1150	730	380	86
 Evolution LPQI350	10.4	2010	430	1150	1150	730	380	86
 Evolution LPQI450	11.8	2390	600	1150	1150	730	380	86
 Evolution LPQI550	13.2	2850	950	1150	1150	730	380	86

Model	Cooling capacity (kW)	Airflow (L/s) at 80Pa <sup>11</sup>	Nominal power motor (W)	Length (mm)	Width (mm)	Height (mm)	Operating weight (kg)
 SuperStealth LCQI250	8.1	1500	340	1150	1150	685	88
 SuperStealth LCQI350	9.9	1990	430	1150	1150	685	88
 SuperStealth LCQI450	13.5	2620	600	1150	1150	835	91
 SuperStealth LCQI550	14.3	3070	950	1150	1150	835	91
Paradigm LCQ350	10.2	1980	430	1150	1150	685	80
Paradigm LCQ450	13.2	2560	600	1150	1150	835	89
Paradigm LCQ550	14.1	2810	950	1150	1150	835	91



Refer to page 6 for details of benefits.

<sup>11</sup> Airflow performances at 80Pa - the equivalent duct static pressure of typical ducted residential multiple outlet installations. The above data was drawn from Meridian Test Laboratory's test analysis. The testing was performed by a NATA accredited laboratory to the requirements of the Australian standard AS2913-2000 "Evaporative Air Conditioning Equipment." Achievable with ambient 38 °C DB, 21 °C WB, room temperature 27.4 °C.

# Coolair

## Technical Specifications

Model	Cooling capacity (kW)	Airflow (L/s) at 80Pa <sup>1</sup>	Nominal power motor (W)	Width (mm)	Depth (mm)	Height (mm)	Operating weight (kg)
CPQ450	8.0	1570	340	1150	1150	685	78
CPQ700	9.5	2000	430	1150	1150	685	79
CPQ850	11.8	2560	600	1150	1150	835	87
CPQ1100	13.3	2710	750	1150	1150	835	89

## How do I choose?

The airflow, and size of the area you wish to cool, will be the largest determinants of which model is best suited to your needs. Whilst it may seem that bigger can only be better, a correctly sized air conditioner for your home will run far more efficiently, which equates to maximised electricity cost savings.

- **Is your home well insulated?** This is a key consideration, as it impacts your home's ability to maintain its temperature. A well insulated home may need a lower capacity unit, in comparison to a poorly insulated home.
- **What climate will your home operate in?** The hotter the climate, the greater the demand on your air conditioning.
- **What additional benefits are important to you?** Seeley International evaporative air conditioners offer additional technology benefits like winter seals, SuperStealth® fans, inverter motors, water savers, and architecturally designed units for greater aesthetic appeal.



The Breezair Supercool® range is available exclusively through Climate Masters of Seeley International Dealers.



# Harness the *simplicity* of **MAGI@TOUCH**® controller

## Touch screen technology

Smart, sophisticated and incredibly intuitive, your MagIQtouch® controller makes operating your evaporative air conditioner a breeze. Control the temperature, fan speed and many more features on a user friendly touch screen. The discreet and modern design will blend seamlessly into the décor of your home.

## Main Features



### Program mode

Programmable 7 day, 4 time period program, customisable to suit your lifestyle (including a temporary over-ride function).



### Energy saving quiet night mode

A comfortable nights sleep that won't cost the earth. The energy saving quiet night mode automatically reduces fan speed during the night for even greater economy at lower noise levels.



### Manual mode

Manually control temperature and/or fan speed settings, at will.



### Cooling & Heating

Control both your cooling and heating from one MagIQtouch® controller.



### Auto-clean™ Function

World's first fully automated pad cleansing capability enables you to set and forget, ensuring your cooling pads remain clean, fresh and functional all summer long, season after season<sup>12</sup>.



### Useful settings

Access additional features such as child lock, and servicing information.

## Optional Extra: MagIQtouch® Air Sensor

The MagIQtouch® Air Sensor monitors temperature and humidity levels. It allows you to mount your MagIQtouch® controller in the most convenient place in your home, as the MagIQtouch® Air Sensor will then take over temperature control from the MagIQtouch® controller. This can then be located in the best place in the house to ensure ultimate cooling comfort for everyone.



## Wi-Fi Smart app<sup>13</sup>



Control your cooling comfort needs directly from your mobile device! For example, turn on your cooler wherever you are, ensuring you come home to a cool home on those hot summer days.

The smart app is free and available for download on your smartphone.

## Smart home integration<sup>13</sup>



Control temperature and fan speeds with your voice through Amazon<sup>14</sup> Alexa or Google Assistant<sup>15</sup> technologies.

Voice commands are easy and simple to use, like "Alexa, turn on my Cooler" or "Hey Google, set the Cooler to 21 degrees".

<sup>12</sup>.Only for cooler models fitted with the water management system. Ask your dealer for further information.

<sup>13</sup>.Requires MagIQtouch® wall control, MagIQtouch® Wi-Fi smart kit and MagIQtouch® account to operate. Additional costs may apply.

<sup>14</sup>.Requires Wi-Fi, Google Account and a compatible device. Google and Google Home are trademarks of Google LLC. Additional costs may apply.

<sup>15</sup>.Requires Wi-Fi, Amazon Account and a compatible device. Additional costs may apply.



# Harness the *power* of wifi and wireless



## Controller upgrade options



### Wireless:

- Battery operated Wireless Controller using Radio Frequency technology.
- Ideal for renovations, or where access for cabling is limited.
- Easier to install, the RF option also provides up to 2 master controllers.
- Can control the entire system from 2 locations, rather than 1; an ideal solution for larger, or two storey homes.



### Wifi Enabled<sup>16</sup>:

- **Take complete control of your comfort at home, at all times.**
- Upgrade to a WI-FI module to work with your wired-in MagiQtouch® Controller,<sup>17</sup> enabling you to control your heating directly from your personal device through our smart app.
- The Smart app is available on Android and IOS devices.
- Integrate into voice activated smart home controls like Google Home and Amazon Alexa.

16.Requires MagiQtouch® WI-FI kit, compatible MagiQtouch® controller and MagiQtouch® account to operate. Additional costs may apply.

17.MagiQtouch® WI-FI Module is not compatible with MagiQtouch Wireless Controller. Existing installations including a MagiQtouch® controller may need to be upgraded if purchasing the WI-FI module. Additional costs may apply.



Google Home



amazon echo



Available for download now on iOS and Android



# Additional Information

## Combined heating and cooling solution

A Seeley International Ducted Gas Heater will complement your Evaporative cooling system:

- Warm and cosy in winter; fresh and cool in summer!
- MagIQtouch® controller will seamlessly control **both** heater and cooler systems.
- Braemar has the highest efficiency star ratings in Australia for ducted gas heating<sup>18</sup>.



## Keep your home secure

**Did you know you can cool your home without leaving your doors and windows open?**

Cost effective and easy to install, the **Security Relief Vent™** allows you to run your evaporative air conditioner while you are out, with all your windows and doors safely closed and locked.

Your home will **stay** cool, because the **cool** exhaust air is released into the hot roof space, cooling everything while you're out.

When you return home, if you wish, simply open up your windows and doors as normal - either way, you will **maintain** the delivery of fresh, cool air **throughout** your home.



## Bushfire protection

### Firewall Ember Screen (optional extra)

- Helps guard against ember attack in bushfires.
- Made from non-combustible mesh.
- Maximum aperture of 2mm.
- Can be fitted to existing cooler pad frames.
- Minimal reduction in air flow of around 5%.
- To meet BAL ratings, the cooler **also** requires a Firewall Auto Seal installed.
- Fitting both Ember Screen and Auto Seal to comply with BAL ratings will reduce airflow by up to 15%.

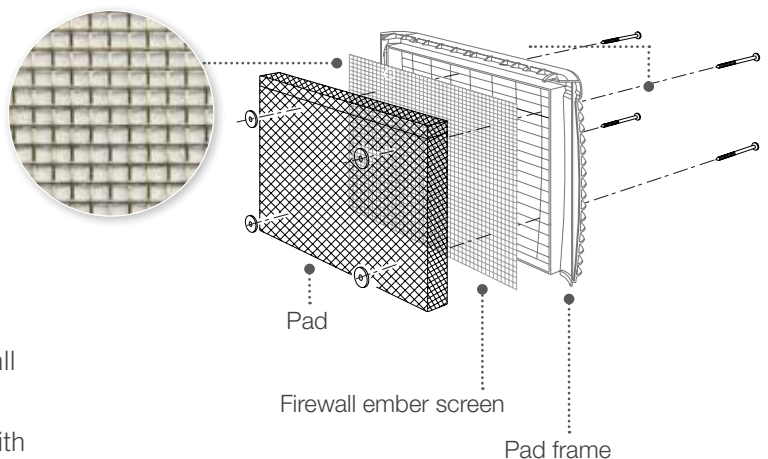

# Warranty Terms

## 7 Year Warranty - Breezair & Braemar

7 year Comprehensive Warranty<sup>19</sup>, 10 year cover on all structural components, plus a hefty 25 year cover against corrosion, on its Permatuf<sup>®</sup> cabinet.



## 5 Year Warranty - Coolair<sup>20</sup>

5 year Warranty, 10 year cover on all structural components, plus a hefty 25 year cover against corrosion, on its Permatuf<sup>®</sup> cabinets.



Register your warranty and go into the draw to win a prize worth \$500<sup>21</sup>.

**Prize includes 2 free services (up to the value of \$400) and a \$100 eftpos gift card**

All you need is your home owners' manual.

Visit [seeleyinternational.com/warranty](https://www.seeleyinternational.com/warranty) and follow the prompts.

Have your serial number ready.

18. 3 to 6 star, and 7 star equivalent products.

20. Coolair 5 Year only warranty applies to products purchased from October 1st 2020.

21. Terms and conditions apply.

See: <https://www.seeleyinternational.com/residential/support/warranty-prize-draw-winners/> for more information, including the dates of the promotion.





Harness the *power* of nature



### BREEZAIR

Ducted Evaporative Air Conditioning

### BRAEMAR

Ducted Evaporative Air Conditioning | Ducted Gas Heating  
Reverse Cycle Air Conditioning | Gas Wall Furnaces and Space Heaters

### THE CLIMATE WIZARD

Micro-Core® Technology

### SUPERCOOL

Ducted Evaporative Air Conditioning

### COOLAIR

Ducted Evaporative Air Conditioning

### COOLERADO

Indirect Evaporative Air Conditioning

### AIRA

Direct and Indirect Evaporative Air Conditioning | Ducted Gas Heating  
Commercial Gas Space Heating | Energy Recovery Systems

### INTEGRATED COMFORT INCORPORATED (ICI)

Dual Cool® Patented Dual Evaporative pre-cooling products

# seeleyinternational.com/residential

## 1300 360 815

2022



With the generous support of our Australasian dealers we are proud to be the National Variety Bash partner supporting kids in need across Australia.

**Seeley International Pty Ltd**  
ABN 23 054 687 035

112 O'Sullivan Beach Road, Lonsdale, SA 5160

Phone: (08) 8328 3850 Fax: (08) 8328 3950

Email: enquiries@seeleyinternational.com

seeleyinternational.com

Information in this brochure was correct at the time of preparation. E & OE



Cat No BML01 REV B DEALER (0921)